

Week 8 Monday Course 3 Warm-up

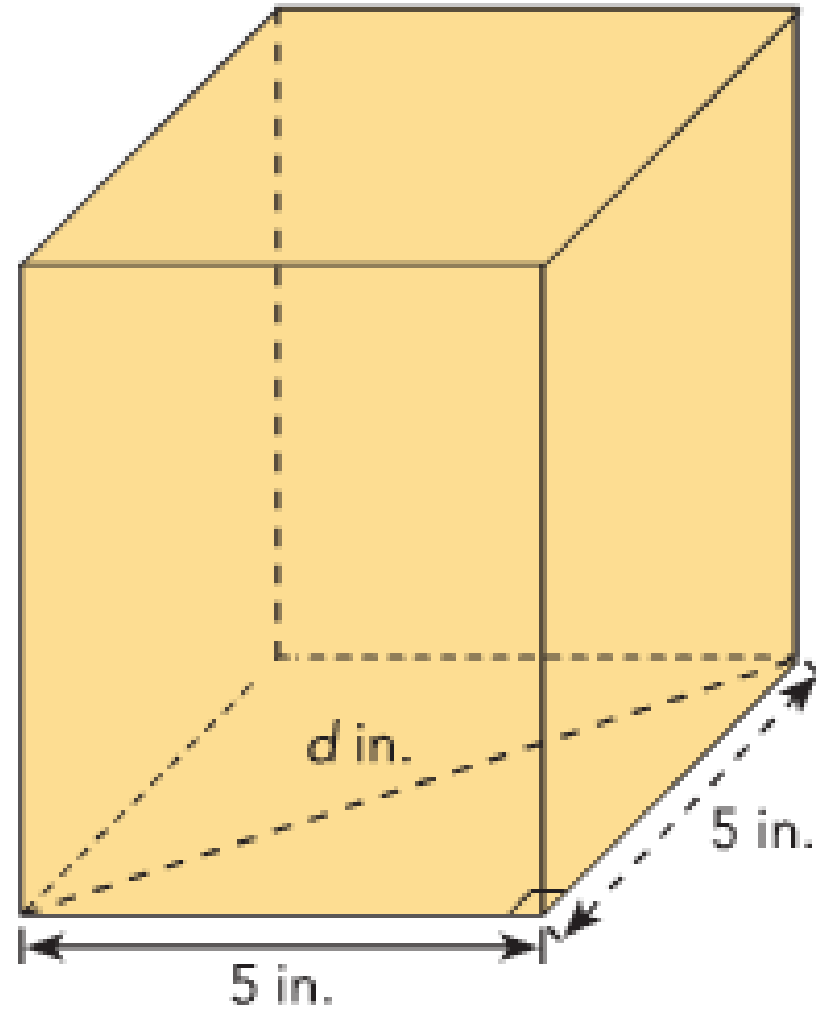

Find the missing variable, d



Week 8 Tuesday Course 3 Warm-up

Find the height of the pyramid in inches

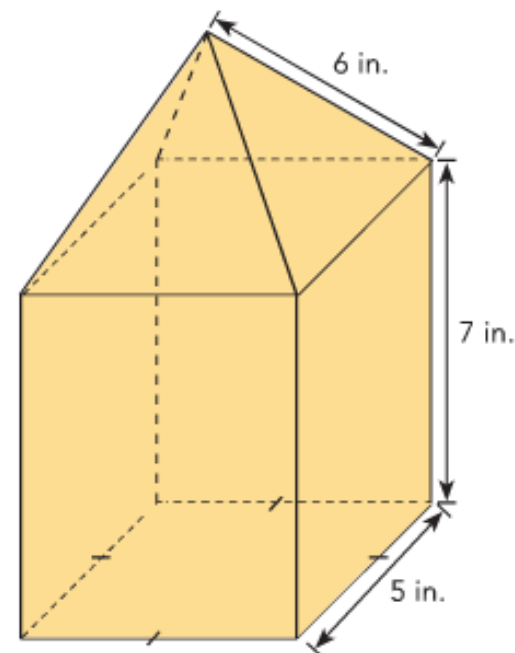
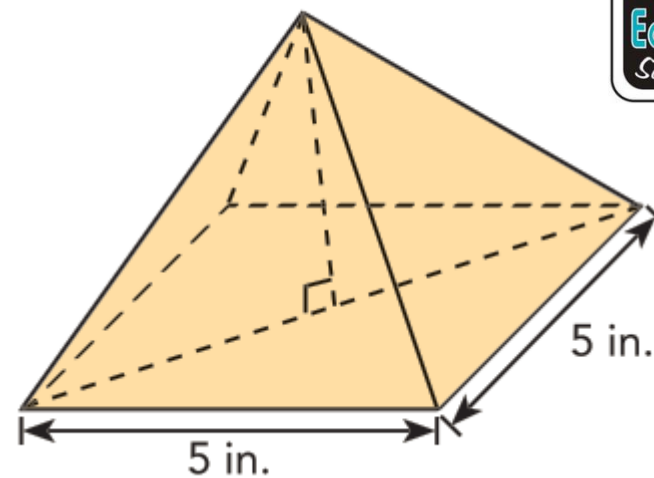

Week 8 Wednesday Course 3 Warm-up

$$\text{Volume} = \frac{1}{3} \cdot \text{Area of base} \cdot \text{Height}$$

Find the volume of the square pyramid

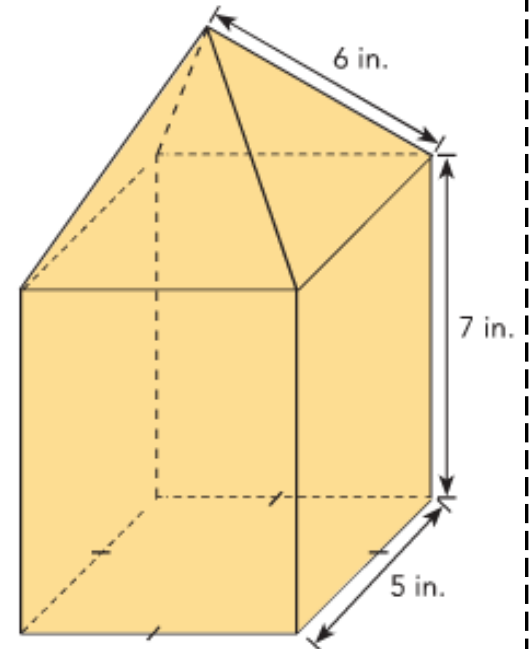
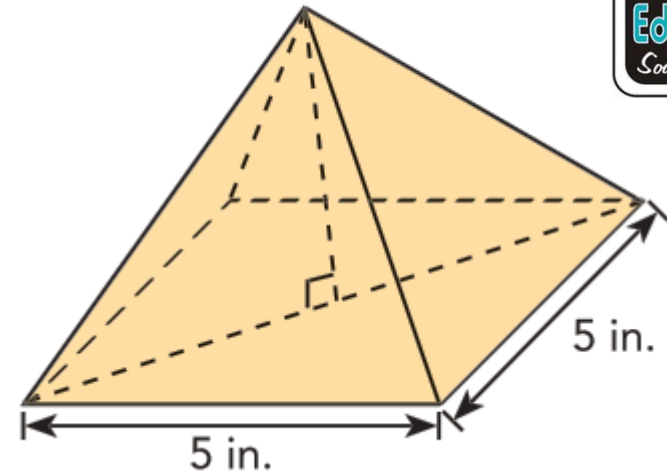

Week 8 Thursday Course 3 Warm-up

$$\text{Volume} = \text{Area of base} \cdot \text{Height}$$

Find the volume of the rectangular prism

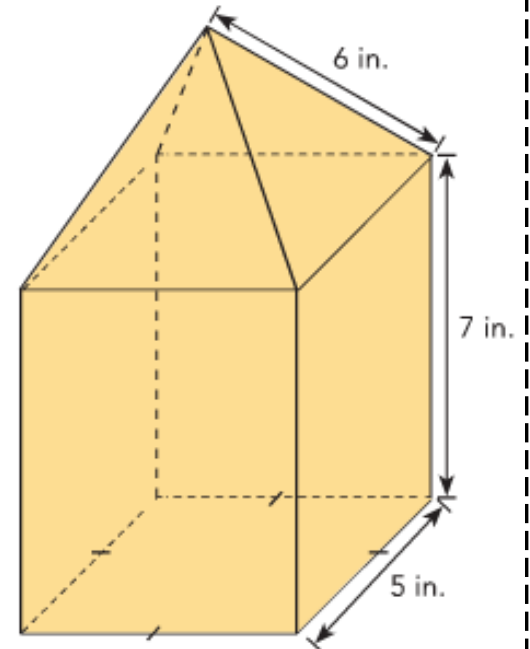
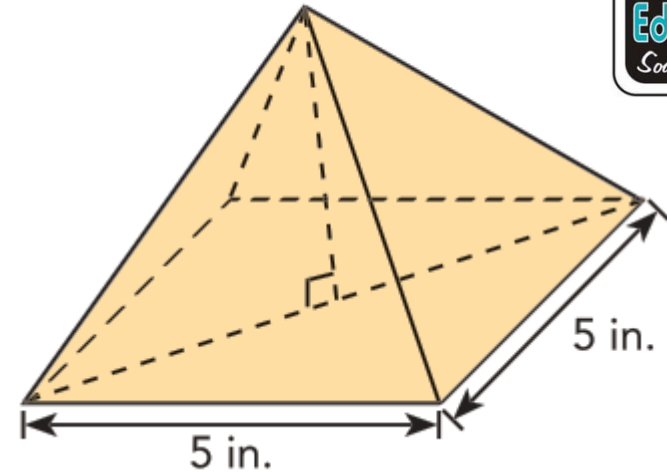

Week 8 Friday Course 3 Warm-up

find the combined volume of the composite solid

